

WEK Light

Instructions for use

EN | 200004302 | 2024-05

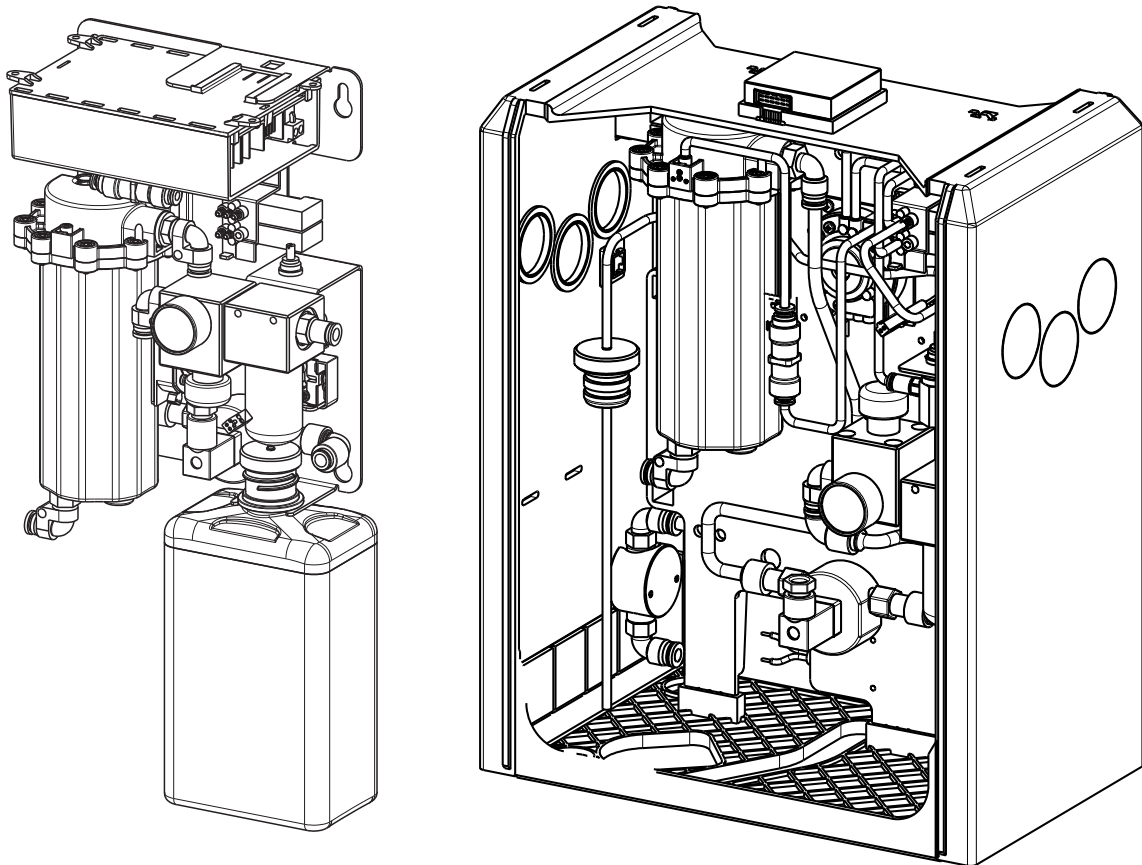

eIFU:
www.metasys.com/downloads





METASYS
protect what you need

Table of contents

1.	Notes	4
1.1.	General instructions	4
1.2.	Explanation of the symbols	4
1.3.	Copyright notice	5
2.	Intended use	6
2.1.	Indication	6
2.2.	Contraindication	6
2.3.	Target group	6
3.	Safety-related information	7
3.1.	General safety-related information	7
3.2.	Safety instructions	7
3.3.	Warnings	7
4.	Product description	8
4.1.	Product description	8
4.2.	Technical data / performance data	8
4.3.	Type plate	9
4.4.	Construction	10
4.5.	Functional description	12
5.	Preparation for use	13
5.1.	Transport and storage	13
5.2.	Installation requirements	13
5.2.1.	Assembly variants	13
5.2.2.	Pipe and hose connections	14
5.2.3.	Filter / pre-filter	14
5.3.	Installation, assembly and commissioning	15
5.3.1.	Installation and assembly of optional accessories, retrofit parts and spare parts	16
5.3.2.	Connecting to other devices	16
5.4.	Electronics	17
5.4.1.	Electrical connections / circuit diagram	17
6.	Use	18
6.1.	External display	18
6.2.	Normal operation	18
6.3.	Additional programs	18
6.4.	Error messages	19
7.	Care and maintenance	20
7.1.	Regular cleaning measures	20
7.2.	Maintenance and service	20
7.2.1.	Function test	20
7.2.2.	1-year maintenance kit	20
7.3.	Replacing the GREEN&CLEAN WK bottle	21
8.	Decommissioning	22
8.1.	Disassembly	22
8.2.	Recycling and disposal	22
9.	Annex	23
9.1.	Order numbers and scope of delivery	23
9.2.	Warranty conditions	26
9.3.	Change history	26

eIFU

		eIFU: www.metasys.com/downloads
		DE, EN, IT, DA, FI, NL
	e-mail	ifu@metasys.com
	Order number	200004302

If you would like to request a printed copy of the instructions for use, please contact us at ifu@metasys.com or use the order form at www.metasys.com/downloads. A hardcopy of the instructions for use will be made available to you free of charge and within seven calendar days of receipt of the request.

Translations

Translation of the original instructions for use

 **Tetras GmbH**
Sirius Business Park, Rupert-Mayer-Str. 44, 81379 Munich, Germany

Images

The images contained in these instructions for use are for reference and may differ from the actual appearance of the product.

1. Notes









































1.1. General instructions

METASYS can only guarantee the safety, reliability and performance of the dental device if the following instructions are adhered to:

- > The product is only to be used in accordance with the instructions for use.
- > During maintenance and service work (inspection, service, repair, replacement), only use original replacement parts.
- > All manufacturer specifications for the treatment units to which the device is connected must be observed.
- > After commissioning, complete the proof of installation and send this to METASYS in order to define the warranty period.
- > All maintenance and service work must be entered into the device logbook.
- > On request by an authorised technician, METASYS will provide all documentation that may be of use to technically qualified personnel during maintenance and service works
- > METASYS accepts no responsibility for damage that may arise due to external influences (defective installation), using incorrect information, improper use of the dental device, or maintenance and service works being carried out improperly.
- > The user must familiarise himself/herself with how to operate the dental device and ensure that the dental device is in good condition each time before operating it.

Important: Read the accompanying documents of the device carefully before installation, commissioning and use and keep them for the entire service life of the product!

1.2. Explanation of the symbols

 CE mark	 End device ready for operation	 Use eye protection
 Medical device	 Loudspeaker	 Use mouth and nose protection
 Item number	 Sound	 Unplug from mains
 Serial number	 Inclination / slope	 General warning sign
 Manufacturer	 Maximum installation altitude	 Warning of electrical voltage
 Date of manufacture	 Blower / fan	 Information
 Follow instructions for use	 On Off	 Download
 Follow instructions for use with reference to eIFU	 Separate collection of electrical/electronic equipment (WEEE)	 Do not cut
 Temperature limit	 Protective earthing	 Maintenance / service
 Caution / attention	 Protection class II	 Stop operation
 Beware of electric shock	 Applied part type BF	 Protect from heat / Protect from sunlight
 Humidity limit	 Applied part type B	 Protect from moisture / Store in a dry place
 Tank empty	 Responsible for the translation	 Fragile
	 Observe instructions for use	 Package orientation at the top



Fault on end device



Use hand protection



Stacking limit n = (quantity)



Name and address of the
authorized representative's
registered office in Switzerland



Unique identifier of a medical
device



UDI marking with standard
compliant HIBC data content

1.3. Copyright notice

All names and contents are protected by copyright. Distribution, duplication or alternative use of this document is only permitted with the written consent of METASYS Medizintechnik.

2. Intended use

The water decontamination system WEK light is used for software-controlled dosing of GREEN&CLEAN WK into the water supply of medical treatment units.

2.1. Indication

Not applicable.

2.2. Contraindication

Not applicable.

2.3. Target group

The device shall be used by trained and qualified personnel exclusively.

3. Safety-related information

3.1. General safety-related information

All serious incidents related to the device must be reported to the manufacturer and the competent authority of the Member State where the user and/or the patient is resident.

3.2. Safety instructions

Assembly, modifications or repairs may only be carried out by authorised qualified personnel who guarantee compliance with the EN 60601-1 standard (international standard on Medical Electrical Equipment and Systems, in particular part 1: General requirements for basic safety).

The electrical installation must comply with the regulations of the IEC (International Electrotechnical Commission).

Medical devices should be handled with care with regard to electromagnetic compatibility. Special safety measures must therefore be taken.

The device is not suitable for operation in explosive areas or in flammable atmospheres.

3.3. Warnings

Danger	Warning of a danger that will directly result in serious injury or death
Warning	Warning of a danger that can result in serious injury or death
Caution	Warning of a danger that can result in minor injury
Attention	Warning of a danger that can result in extensive damage to property

4. Product description

4.1. Product description

The water decontamination system WEK light is used for software-controlled dosing of GREEN&CLEAN WK into the water supply of medical treatment units.

4.2. Technical data / performance data

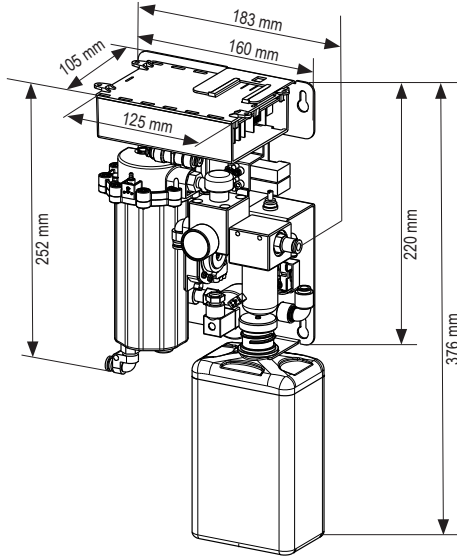
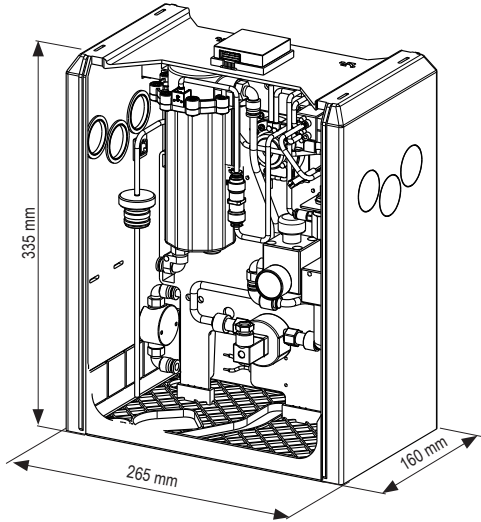
WEK Light	Built-in version	with cover
Power supply	24 V AC	230 V AC
Frequency	50/60 Hz	50/60 Hz
Max. current consumption	200 mA	30 mA
Permissible water pressure	1 - 6 bar	1 - 6 bar
Operating water pressure	inlet pressure dependent / 2,5 bar	inlet pressure dependent / 2,5 bar
Permissible air pressure	4 - 8 bar	4 - 8 bar
Operating air pressure	3,5 bar	3,5 bar
Max. water flow rate	6 l/min	6 l/min
Disinfectant	GREEN&CLEAN WK hydrogen peroxide, 2% solution	GREEN&CLEAN WK hydrogen peroxide, 2% solution
Mixing ratio	1:85 Standard setting 1:42 Intensive decontamination	1:85 Standard setting 1:42 Intensive decontamination
Working solution	235 ppm	235 ppm
Weight	5,9 kg	9,8 kg
Dimensions (H x W x D)	without bottle: 220 x 160 x 105 mm with bottle: 376 x 160 x 105 mm 	335 x 265 x 160 mm 
Water consumption - syringe	100 – 130 ml/min	100 – 130 ml/min
Water consumption - turbines, straight and contra-angle handpieces	50 – 70 ml/min	50 – 70 ml/min
Water consumption - mouth rinsing cup	150 ml/filling of mouth rinsing cup	150 ml/filling of mouth rinsing cup
Class	MD class 1	MD class 1

4.3. Type plate

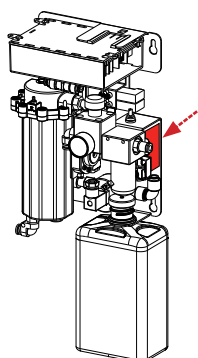

WEK Light Built-in version

The type plate is located on the mounting plate.

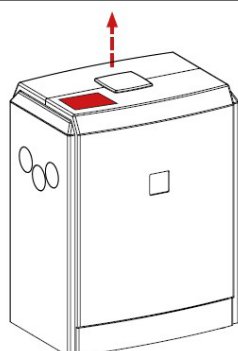

WEK Light with cover

The type plate is located on the housing (next to the external display - push the lid of the cover upwards).

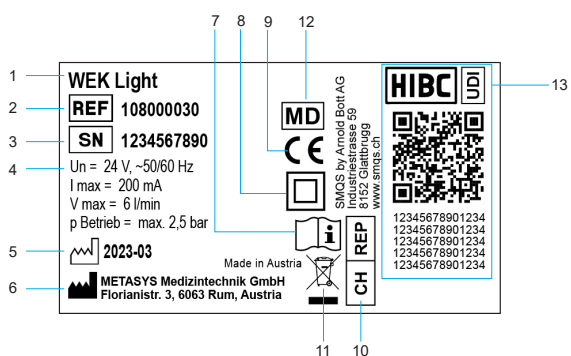

Example picture

1	Device description
2	Item number
3	Serial number
4	Connection data
5	Date of manufacture
6	Manufacturer
7	Follow instructions for use
8	Protection class II
9	CE mark
10	Name and address of the authorized representative's registered office in Switzerland
11	Separate collection of electrical/electronic equipment (WEEE)
12	Medical device
13	Unique identifier of a medical device, UDI marking with standard compliant HIBC data content

4.4. Construction

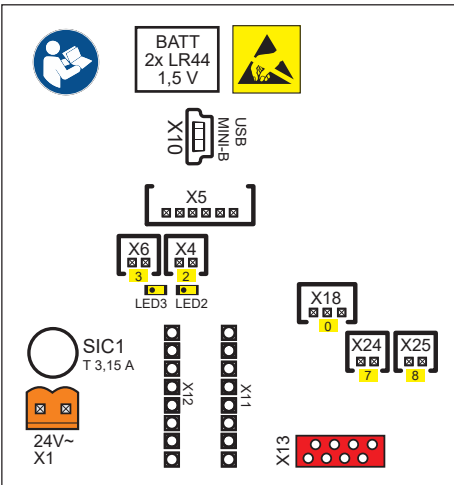
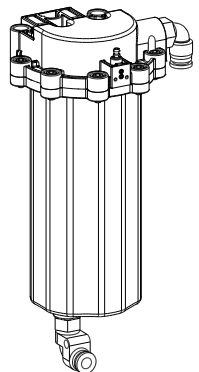
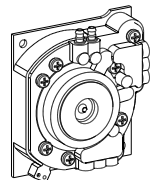
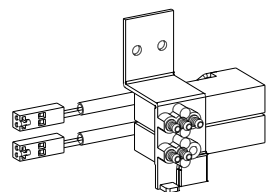
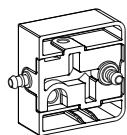
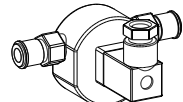
<p>Module 1</p>	<p>Control electronics</p>	
<p>Module 2</p>	<p>Mixing tank; this is where the water is mixed with the disinfectant.</p>	
<p>Module 3</p>	<p>Double membrane pump and membrane rupture sensor</p>	
<p>Module 4</p>	<p>Magnetic block: This controls the addition of the disinfectant via the double membrane pump.</p>	
<p>Module 5</p>	<p>Disinfectant sensor</p>	
<p>Module 6</p>	<p>Flow meter</p>	

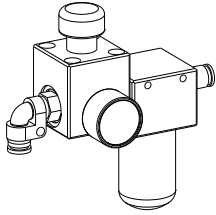
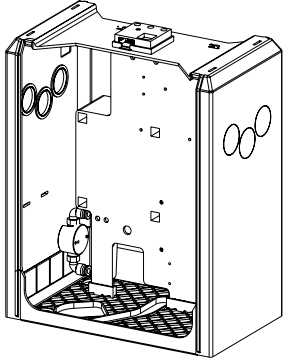
Module 7	Water inlet filter, 80 µm, pressure regulator	
Module 8	Additional housing (optional); consisting of housing, mounting plate, main water tap with pre-filter (80 µm), transformer and main switch.	

4.5. Functional description

The incoming water via the water connection is fed to the mixing container via the water inlet filter and the flow meter. The flow meter measures the flow rate of the water. After the flow rate of 150 ml, the flow meter emits an electronic pulse, which in turn activates magnetic valve 1 via the circuit board. Magnetic valve 1 opens and approx. 1.75 ml of disinfectant solution is added to the mixing container via the compressed air-operated double membrane pump. If a consumer is activated, the consumption medium now flows from the mixing container to the corresponding consumer.

The disinfectant is drawn from the GREEN&CLEAN WK bottle. A disinfectant sensor monitors the presence of GREEN&CLEAN WK. If the container of the GREEN&CLEAN WK is empty, an empty message appears.

Please note that only GREEN&CLEAN WK may be used, as the electronic sensor system is matched to it!

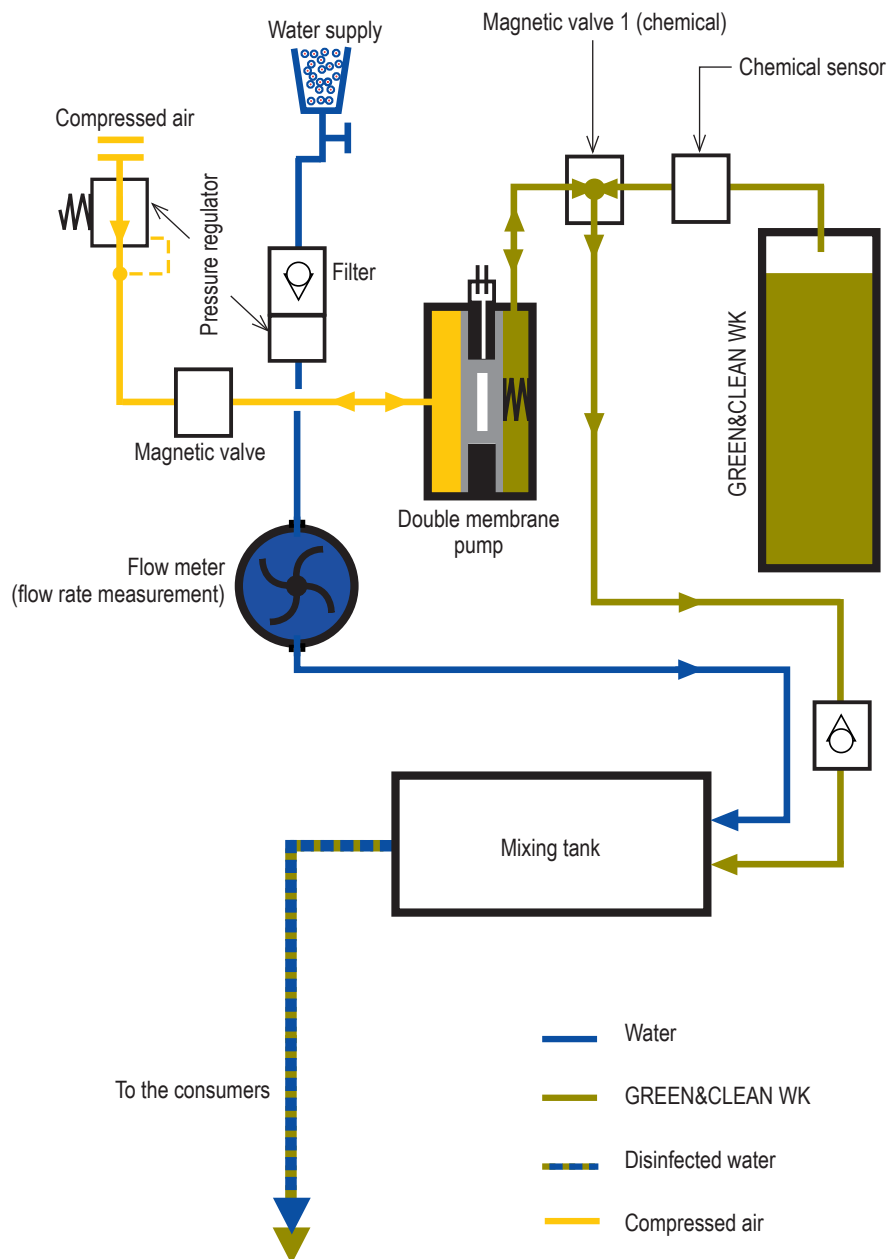



5. Preparation for use

5.1. Transport and storage



Device with cover: The device is shipped in two polystyrene trays fastened together in a cardboard box.

Built-in version: The device is shipped in a cardboard box with bubble wrap.

This original packaging must be used for any onward and return transport. The device must always be transported and stored in an upright position. The device must be transported to the installation site in a completely packed state. After unpacking the device, check for completeness and possible transport damage.

	Transport and storage temperature	0 °C – 70 °C
	Transport and storage humidity limitation	max. 80%

5.2. Installation requirements

	Operating temperature	10 °C – 40 °C
	Humidity limit	max. 70%
	above sea level	≤ 3000 m

5.2.1. Assembly variants

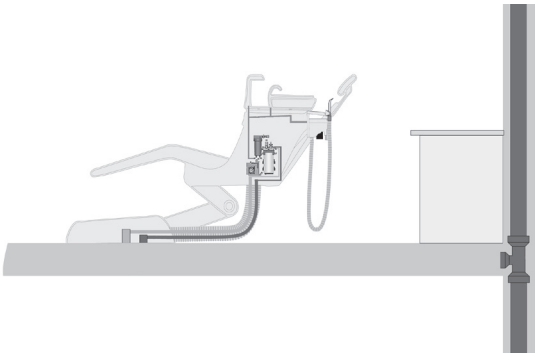
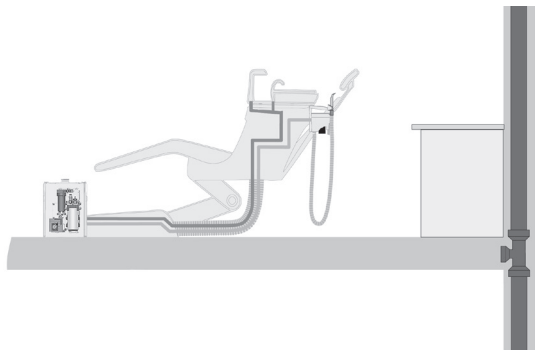
	<p>Installation in the treatment unit</p> <p>The direct integration of the water disinfection system into the treatment unit should be the preferred solution, as the hose and compressed air routes to the device can be kept as short as possible.</p> <p>In the unit, vibration-free suspension of the device on load-bearing parts of the treatment unit must be ensured.</p>
	<p>Installation with cover</p> <p>If it is not possible to install the device directly in the treatment unit, the set-up can also be carried out in the optionally available cover.</p> <p>The cover should be mounted on the connection box of the treatment unit. The external display and a transformer are already integrated in the cover.</p>

5.2.2. Pipe and hose connections

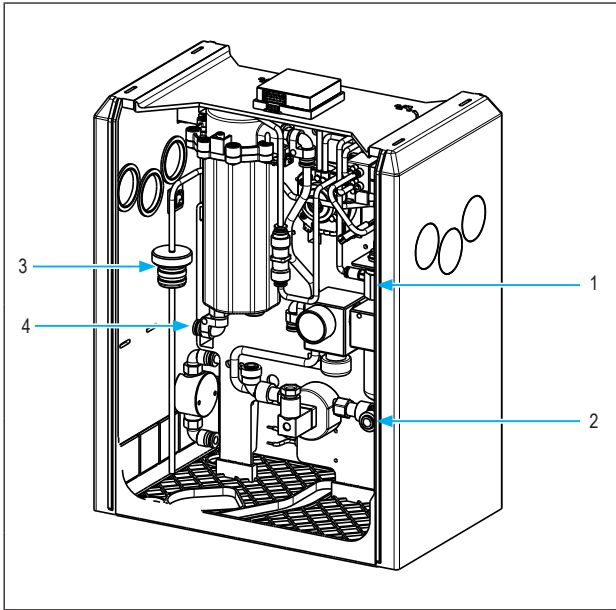

Compressed air connection	
1	Permissible inlet pressure 3.5 - 8 bar PUR hose Inner diameter = 2.5 mm / outer diameter = 4 mm
Water connection (fresh water)	
2	Permissible inlet pressure 1-6 bar PE/PA hose (with KTW approval) Inner diameter = 4 mm / outer diameter = 6 mm
GREEN&CLEAN WK bottle connection	
3	PVC hose Inner diameter = 2 mm / outer diameter = 4 mm
Water outlet connection (to the consumers)	
4	PUR hose Inner diameter = 4 mm / outer diameter = 6 mm



5.2.3. Filter / pre-filter

If not already integrated in the treatment unit, a pre-filter with a maximum mesh size of 80 µm must be fitted upstream of the water connection of the WEK Light.

5.3. Installation, assembly and commissioning

- 1 Read the instructions carefully before installation and commissioning!
Meet spatial requirements



see 5.2. Installation requirements

- 2 Connecting the compressed air and the consumer

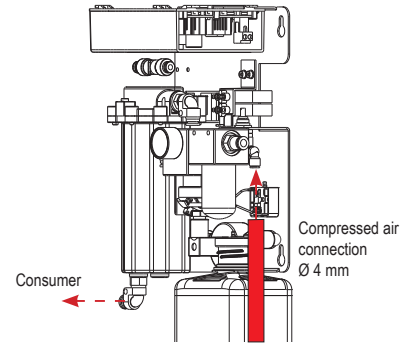

- 3 Fresh water connection (water connection)
(PE/PA hose with KTW approval; permissible inlet pressure: 1 - 6 bar)
Connection of the GREEN&CLEAN WK bottle (750 ml)

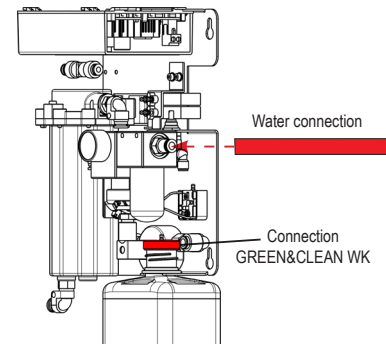

- 4 Connect the electrical connections according to the instructions
5 Only for WEK with cover: First open the ball valve, then switch on the device

see 5.4 Electronics

- 6 When LED 1 lights up green, the device is ready for operation.

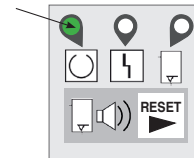

Inform the dentist about product function, operation, care and warranty conditions.

- 7 Fill in the installation proof and device logbook and return them to METASYS (installation@metasys.com)

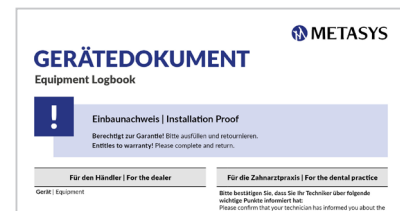

5.3.1. Installation and assembly of optional accessories, retrofit parts and spare parts



Assembly, modifications and repairs may only be carried out exclusively by authorised specialist personnel (see 3.2. Safety instructions)! The METASYS technical customer service is also available for further information and assistance in carrying out repairs, retrofitting, fault analyses, etc.

Please note that the transformer is still live when the device is switched off (main switch WEK set to OFF)! Before carrying out any installations or repairs, disconnect the device from the mains using the device/practice main switch!

5.3.2. Connecting to other devices

When connecting the METASYS device to other devices or systems, hazards can arise. It must therefore be ensured that no hazards arise for the user or the patient and that the environment is not affected. The specifications of the manufacturer of the device or system to be connected must be observed.

5.4. Electronics

The mains connection may only be carried out by a qualified electrician. The electrical installation must be carried out in accordance with the applicable local regulations. Before connecting to the mains, compare the rated voltage on the device type plate with the mains voltage.

Main switch:

It must be ensured that the power supply is connected after the device/practice main switch.



Danger:

The supply voltage must be taken from a safety transformer that meets the requirements of EN 60601-1 and EN 61558-2-6.

Danger:

Fuses may only be replaced by the same type!

5.4.1. Electrical connections / circuit diagram

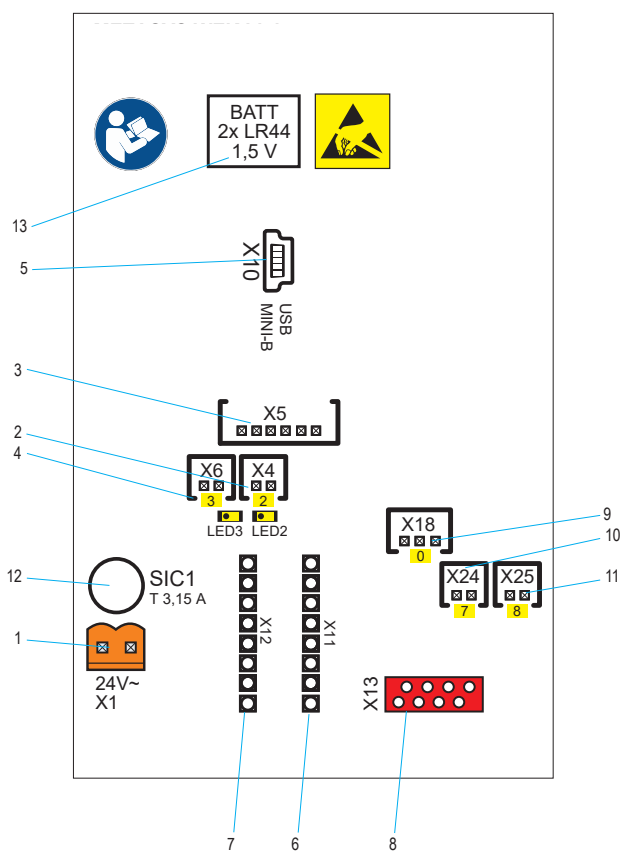

1 X1 - Power supply 24 V AC (orange)



The supply voltage must be taken from a safety transformer that meets the requirements of EN 60601-1 and EN 61558-2-6.

2 X4 - Compressed air magnetic valve (MV3, LED3)

3 X5 - External display

4 X6 - Magnetic valve disinfectant (MV2, LED2)

5 X10 - USB Mini-B connection

6 No function

7 No function

8 No function

9 X18 - Flow meter (flow rate measurement)

10 X24 - SP5 Disinfectant sensor

11 X25 - Membrane rupture sensor

12 Main fuse MST 3.15 A/ UN 250V
(Fuses may only be replaced by the same type!)

13 Back-up battery 2x LR44 1.5 V

6. Use

6.1. External display

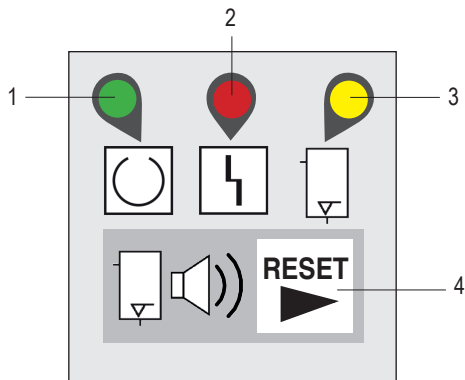

1	LED 1	green	ready for operation
2	LED 2	red	Fault see 6.4 Error messages
3	LED 3	yellow	Disinfection display
4	RESET	no color	RESET button

6.2. Normal operation

Program	Description
Switching on	LED 1 lights up constantly, LED 2 lights up briefly and the device is ready for operation.
	In the event of an error, the device does not go into operation; the error is displayed on the control panel (see 6.4).

6.3. Additional programs

Program	Description
Intensive decontamination	To increase the concentration of GREEN&CLEAN WK if necessary, intensive decontamination can be activated by pressing the RESET button for 4 seconds (LED 1 flashes) until the first beep.
	During this process, LED 1 lights up constantly and LED 3 flashes. This is followed by 6 doses of chemicals distributed over approximately 700 ml volume.
	After the intensive decontamination, LED 3 goes out - the WEK Light is back in normal operation.

6.4. Error messages

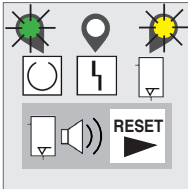
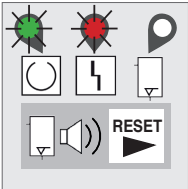

Assembly, modifications and repairs may only be carried out exclusively by authorised specialist personnel (see 3.2. Safety instructions)! For further information and assistance in carrying out repairs, retrofitting, fault analyses, etc., the METASYS technical customer service is also available!

Error message	Possible cause	Countermeasures	Consequence
LED 1 lights up green LED 3 lights up yellow Buzzer tone 	Disinfection of the service water is not carried out	Change the GREEN&CLEAN WK bottle (see 7.3)! If the bottle cannot be changed immediately, press the RESET button to deactivate the buzzer.	The device remains functional, the dentist's workflow is not interrupted, but no disinfection takes place. However, a short buzzer will continue to sound periodically. If the error message was only caused by an air bubble, the error message will disappear on its own at the next attempt.
LED 1 lights up green LED 2 lights up red Buzzer sound 	Defective double membrane pump	Check double membrane pump and circuit board.	All valves and the pump are switched off. The buzzer can be switched off with the RESET button. Once the cause has been rectified, the WEK Light can only be reactivated by switching it off and on again.

7. Care and maintenance

7.1. Regular cleaning measures

The following cleaning measures must be carried out regularly:

Measure	Interval	
Function test	weekly (recommended)	see 7.2.1
1-year maintenance kit	once a year	see 7.2.2
Replacing the GREEN&CLEAN WK bottle	if required	see 7.3

7.2. Maintenance and service



Assembly, modifications and repairs may only be carried out exclusively by authorised specialist personnel (see 3.2. Safety instructions)! For further information and assistance in carrying out repairs, retrofitting, fault analyses, etc., the METASYS technical customer service is also available!

Please note that the transformer is still live when the device is switched off (main switch WEK set to OFF)! Before carrying out any installations or repairs, disconnect the device from the mains using the device/practice main switch!

7.2.1. Function test

1 The GREEN&CLEAN WK test strips can be used to check whether the correct amount of hydrogen peroxide is being mixed with the process water. It is recommended that this check is carried out weekly.



2 For information on use and safety instructions, see the GREEN&CLEAN WK instructions for use.



7.2.2. 1-year maintenance kit

An annual service of the WEK Light water decontamination system (service kit order no. 120000613) is mandatory. This service includes a complete functional check of the device, as well as checking or replacing the following parts:

1 Non-return valve

2 Valve connection plate with magnetic valves

3 Pre-filter insert 80µm

4 Bottle connector

Various hose connections

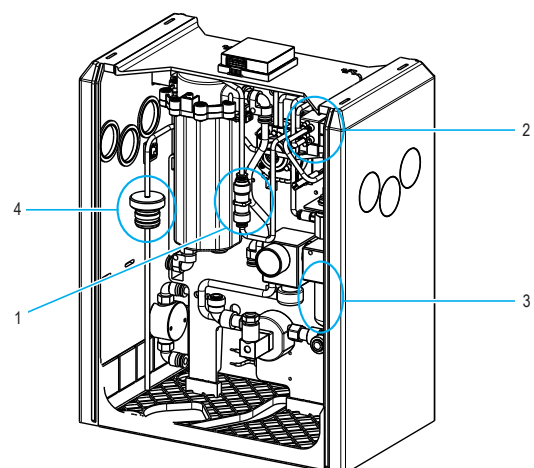

A service must be carried out every 2 years using the service kit order no. 12000051. The service includes changing the magnetic valve block, replacing the pre-filter insert, as well as 1 x GREEN&CLEAN WK and 5 x GREEN&CLEAN WK test strips.

7.3. Replacing the GREEN&CLEAN WK bottle

- 1 Remove the empty GREEN&CLEAN WK bottle from the device.



- 2 Pull the push-in cap (incl. hose) out of the bottle.

- 3 Insert the tube into the new GREEN&CLEAN WK bottle and press on the push-in cap.

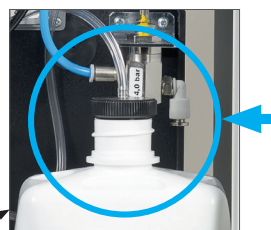

- 4 Place the bottle back in the device. Make sure that the hose is connected to the chemical connection!



For information on use and safety instructions, see the GREEN&CLEAN WK instructions for use.



8. Decommissioning

8.1. Disassembly



Warning:

Remove from power source before disassembly!



Warning:

Risk of contamination: To avoid infection, wear personal protective equipment (hand, eye, nose and mouth protection) and disinfect and clean the device!

If it is necessary to return the device to the depot or to METASYS, the original METASYS packaging must be used. Before packing the METASYS device to be transported, clean and disinfect it. Possible openings where residual fluids could escape must be closed.

8.2. Recycling and disposal



The device may be contaminated! Advise the disposal company of this so that appropriate precautions can be taken. Parts that are contaminated with amalgam, such as sieves, filters, hoses, etc., must also be disposed of in accordance with the national regulations.

Uncontaminated plastic parts of the device can be recycled as normal plastics. The integrated electronic components (including circuit board) are to be disposed of as electronic waste. Metal parts are to be disposed of as scrap metal.

Alternatively, the device can be returned to the manufacturer for proper disposal. Before packing the METASYS device to be transported, clean and disinfect it. Possible openings where residual fluids could escape must be closed. The original METASYS packaging must be used for shipping.

The proof of installation and the device logbook must be kept for 5 years after the device has been disposed of.

9. Annex

9.1. Order numbers and scope of delivery

Order number (new)	Order number (previous)	Designation	Scope of delivery
108000029	05020026	WEK Light Water decontamination system, with cover, 230V, without DVGW	Device, standard version with cover, with instructions for use
108000030	05020019	WEK Light Water decontamination system, without DVGW	Device, standard version, with instructions for use
108000031	05020038	WEK Light Water decontamination system, HEKA version, without DVGW	Device, HEKA version, with instructions for use
108000032	05020047	WEK Light Water decontamination system, Fimet version, without DVGW	Device, Fimet version, with instructions for use
108000033	05020034	WEK Light Water decontamination system, OMS version, without DVGW	Device, OMS version, with instructions for use

Accessories, service kits, collection containers and spare parts

Application aides

Order number (new)	Order number (previous)	Designation
121000013	40200018	AH GREEN&CLEAN, WK, dosing cup
121000014	40200020	AH GREEN&CLEAN, WK, dosing aid for bottle system, compatible with 750 ml bottle

Service kits

Order number (new)	Order number (previous)	Designation
120000051	50050126	ET WEK Light, 1-year maintenance kit, hygiene set
120000613	-	ET WEK Light, 1-year maintenance kit

Consumables

Order number (new)	Order number (previous)	Designation
121000015	40050503	AH GREEN&CLEAN, WK, test strips, 25 pcs.
121000016	40050502	AH GREEN&CLEAN, WK, test strips, 5 pcs.
122000056	60040101	GREEN&CLEAN WK 1000 ml, 6 bottles
122000057	60040100-1	GREEN&CLEAN WK 750 ml, 4 bottles

Spare parts

Order number (new)	Order number (previous)	Designation
120000002	50050106	ET WEK/Light, ball valve
120000003	50050124	ET WEK/Light, insert pre-filter 80 µm
120000004	50050113	ET WEK/Light, built-in device, external display
120000005	50050005	ET WEK/Light, double membrane pump
120000006	50050307	ET WEK/Light, chemical sensor
120000007	50050102	ET WEK/Light, side plate, external display
120000008	40080001	ET WEK, pre-filter inlet, 6 mm
120000021	50120015	ET WEK, magnetic valve
120000023	50050107	ET WEK, ball valve holder
120000024	50050131	ET WEK, rubber buffer, gray housing, 4 pcs.

120000025	50050305	ET WEK, flow meter
120000027	50050104	ET WEK, pressure regulator
120000035	50050111	ET WEK, spout
120000043	50050308	ET WEK Light, non-return valve
120000045	50050302	ET WEK Light, mixing tank
120000046	50050306	ET WEK Light, magnetic valve block
120000047	50050311	ET WEK Light, HEKA, main circuit board
120000048	50050312	ET WEK Light, HEKA, flow meter
120000049	50050301	ET WEK Light, main circuit board
120000050	50050310	ET WEK Light, pressure reducer
120000149	40500001	ET MST 1/WEK, cover version, toroidal transformer

Wasserentkeimung WEK Light

Water decontamination system WEK Light

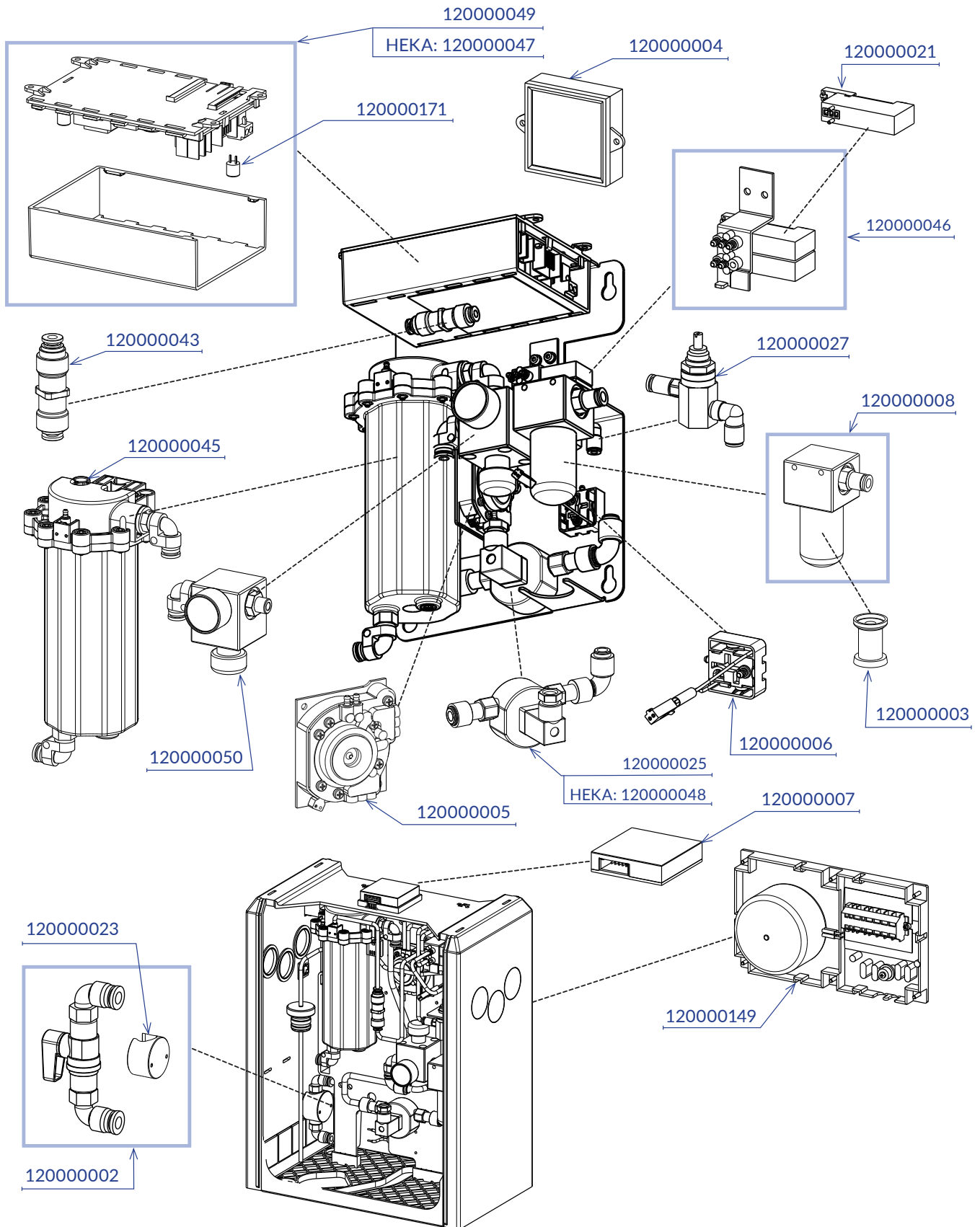

9.2. Warranty conditions

METASYS grants a guarantee of 12-36 months for specific products (duration of guarantee depends on the product according to the information in the current price list).

The guarantee covers all material faults that more than negligibly affect the function of the device. The guarantee does not cover damages caused by incorrect or improper handling as well as normal wear. Furthermore, the guarantee does not apply to the replacement of the amalgam collection container or to fragile parts such as glass, plastic, hoses, filters, condensate filters or membranes. Any incurred working and travel times are excluded from the warranty.

In order to determine the validity of the guarantee, the installation proof accompanying the device must be returned to METASYS immediately after proper assembly has taken place. In this case the warranty period begins with commissioning. In the event of installation without returning the installation proof to METASYS, any warranty claim is forfeited. Installation and return of installation proof must be completed within 24 months from the date of sale from METASYS.

Furthermore, any warranty claims of the customer expire if only one of the following circumstances arises, regardless of whether the circumstances arise for the customer of METASYS or a later owner or operator:

- > Improper installation, operation, maintenance or transport of the device. If METASYS parts have to be returned, the original METASYS packaging must be used for shipping. Prior to packaging and shipping, the METASYS device must be cleaned and disinfected. Any openings where residual fluids could leak must be closed.
- > Installation and return of installation proof have not been completed in the aforementioned 24 months.
- > Failure to send the Installation Proof to METASYS.
- > Installation and use of non-original METASYS parts.
- > Installation of the device by personnel who are neither trained nor authorized by METASYS.
- > Occurrence of damages through improper handling and operation or use of unapproved cleaning and/or disinfecting material, as well as non-compliance with the instructions for use.
- > Execution of repairs by unauthorised repair shops or unauthorised personnel.
- > Failure to comply with the prescribed maintenance intervals. Maintenance must be carried out 11-12 / 23-24 / 35-36 months after installation of the respective METASYS item.
- > Missing entries in the Equipment Logbook regarding the installation as well as prescribed servicing by technicians trained by METASYS.
- > Failure to take reasonable immediate measures to avoid further damages in the event of a malfunction.
- > Shipping of devices or components to METASYS without proper accompanying paperwork, in particular without error description or invoice for the purchase of the device.
- > Failure to provide visual images (photos, video clips ...) of the METASYS item complained about, as well as of its installation situation and ambient conditions.

METASYS reserves the right to demand the documentation supplied with the device to check the maintenance intervals for the assertion of warranty claims. The processing of warranty claims takes place exclusively according to the following method:

In the event of malfunctions, the device must be opened by an authorized technician, the relevant component taken out and sent to METASYS unopened and cleaned. The customer sends the device or component in question to METASYS at his own expense. METASYS checks whether there is a warranty claim. METASYS will repair the device or component if it is cost-effective. The customer is charged for the costs incurred for the repair, but not the replacement parts covered by the guarantee. The consignment of the device or component to METASYS always represents a repair order for METASYS. For cost estimates for the repair of returned devices, a processing fee* is charged if the warranty period has expired or no warranty case exists. For products inspections only without any cost estimates a processing fee* can be charged. When sending the device or component to METASYS, an error description with all importation information about the device must always be included. The customer of METASYS may only provide payment in advance after consultation with METASYS. Only the affected component is to be sent in (smallest possible unit). If contaminated, intact parts are sent to METASYS without technical necessity, METASYS is entitled to destroy them without separate payment. The new part corresponding to the part to be destroyed is only delivered after a separate order and invoice. In any case, METASYS has the right to handle the guarantee through credit note or the return of new parts without conducting repairs. Guarantee services do not result in an extension of the warranty period nor do they initiate a new warranty period. The warranty period for installed replacement parts ends with that for the originally delivered device. The METASYS customer is obligated to make his customer aware of the conditions regarding the warranty processing. The statutory warranty rights of the customer remain unaffected.

* The current warranty conditions and fees can be found in the current METASYS price list.

9.3. Change history

Revision	Date	Description
200004302	30.04.2024	Newly created.

Corrected various spelling and translation errors.



protect what you need



METASYS Medizintechnik GmbH

Florianstraße 3 | 6063 Rum bei Innsbruck | Austria
T +43 512 205420 | info@metasys.com | metasys.com

Subject to printing and setting errors!